



Installation Instructions Invisible Loudspeakers

DEplan®





Patented flat plate sound transducers for invisible mounting in ceilings and walls.

The different models in the DE Plan Series combine cone speakers in the low-frequency range, exciters in the high-frequency range and complex crossovers to offer outstanding sound properties and excellent low frequency characteristics.

pure listening 



Content

1. Models	4
2. Scope of delivery	5
3. Covering materials	6
4. Important notes on installation	6
5. Construction and mounting in ceilings and walls	6
6. Other commonly used materials and surfaces	7
7. Influence of additional layers of paint when redecorating	7
8. Installation in non-concrete walls and ceilings (without back box)	8
9. Installation in drywall walls and ceilings with a back box	12
10. Installation in solid walls using EGB Plan back boxes	16
11. Installation in concrete ceilings cast in place with EGB Plan series back boxes	19
12. Installation in concrete ceilings with the EGB Plan series	20
13. Technical data loudspeakers	22
14. Technical data back boxes	22



**DE Plan installation videos
with or without back box**
on Youtube

1. Models

Connectors/cable type

DE Plan 200
2-way flat transducer

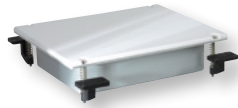

2-pole
2 x 1,5 mm² up to 30 m
2 x 2,5 mm² up to 50 m



DE Plan 400
2-way flat transducer



2-pole
2 x 1,5 mm² up to 30 m
2 x 2,5 mm² up to 50 m



DE Plan 500 S
2-way flat transducer
with small construction



2-pole
2 x 1,5 mm² up to 30 m
2 x 2,5 mm² up to 50 m



DE Plan 600
High-End 2-way flat transducer



2-pole
2 x 1,5 mm² up to 30 m
2 x 2,5 mm² up to 50 m



DE Plan 200 ST
Stereo 2-way flat transducer



2 x 2-pole
2 x 2 x 1,5 mm² up to 30 m
2 x 2 x 2,5 mm² up to 50 m

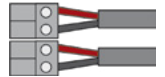

DE Plan 600 AIArray
4-channel flat transducer for
controllable beam direction

Only in combination with system power
amplifiers of the PA DSC Series.



8-pole
8 x 0,75 mm² up to 20 m
8 x 1,5 mm² up to 50 m

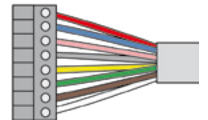

DE Plan 600 SUB
Flat subwoofer



2-pole
2 x 1,5 mm² up to 20 m
2 x 2,5 mm² up to 35 m



2. Included Components

The following components are included in your delivery for every speaker.

- **Assembly frame**

For positioning the mounting feet. Pre-assembled with

55 mm springs and 60 mm screws for wall thicknesses of **10 – 25 mm**.

If you are installing speakers with back boxes, the mounting feet are already installed in the back boxes and you will not need the assembly frame.

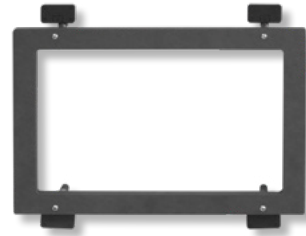

- **Quick-fix screws**

3.9 x 45 quick-fix screws for attaching the mounting feet in drywall



- **75 mm springs and 80 mm screws**

For wall thicknesses of **20 – 45 mm** (incl. back box)

Use 75 mm springs and 80 mm screws for double panels with 12.5 mm drywall boards and a back box or when installing in solid walls and concrete ceilings with EGB Plan series back boxes.



- **O-Rings**

to secure assembly screws while inserting the speakers.



- **Glass fiber lining**

For covering the speaker and the seam between it and the mounting surface.



- **Adhesive**

Dispersion adhesive for attaching the glass fiber lining.



3. Construction and mounting in ceilings and walls



4. Important notes on installation

Read and follow the following installation notes and these instructions before installing this product.

- We recommend that all lining, plastering and painting work is carried out by qualified professionals. The speaker will only deliver the desired visual and acoustic results if it is installed correctly.
- Drying times between the individual steps must be observed.
- If you are using a different method and materials, we strongly recommend that you prepare a sample area and see how this performs. Solutions for other installation scenarios are available on request. Please contact us if you have any questions.
- Damage resulting from incorrect handling is not covered by the warranty.

5. Information about covering materials and surfaces

The sound properties of DE Plan speakers are influenced by the material placed over the membrane. The standard for DE Plan speakers is flush mounting in a closed structure with the glass fiber fleece provided placed around the membrane. A thin layer of plaster is applied and sanded down, and one to three coats of paint are applied over the area.

Using a different method to cover speakers

Wenn ein anderer Schichtaufbau erfolgen soll, müssen folgende mechanische und akustische Aspekte unbedingt berücksichtigt werden:

- Applying heavy layers of material over the speaker membrane (thickness of the material itself and total thickness of all layers) can significantly reduce efficiency levels, especially in the mid-high range from approximately 1,000 Hz.

- If you are using a different (non-standard) method to cover the speakers, you must use a digital signal processor (DSP) in the amplifier system to adjust the sound. We recommend our PA DSC series power amplifiers.
- The membrane itself is flexible. If it is covered in layers of brittle material such as plaster or render thicker than 1 mm, cracks may appear in this area when it is subject to mechanical stress, for example, from a paint roller being pushed against it while painting.
- If you are installing speakers in an open structure such as suspended panels or acoustic ceilings, please use a back box to prevent an acoustic short circuit from occurring between the front and rear of the speaker.

If you have any doubts, we recommend preparing a sample area and seeing how this performs.
Please contact us if you have any questions.

6. Other commonly used materials and surfaces

- **Plastered wall surfaces (e.g. stucco lustro)**

This method of covering the membrane is mechanically and acoustically similar to the standard technique. Applying layers of plaster thicker than 1 mm will increasingly dampen the mid-high range. If you use a plaster that does not bond properly with the surface, cracks may appear in the membrane area if it is subject to mechanical stress. If you have any doubts, we recommend preparing a sample area and seeing how this performs.

- **Wallpaper**

In general, covering a speaker with wallpaper does not pose any mechanical problems and is highly suitable in terms of acoustics. Heavy wallpaper can slightly dampen the mid-high range depending on the weight per square meter (g/m²) and stiffness. Use the adhesive provided to apply the wallpaper to the speaker membrane. Wallpaper paste is not strong enough to fix the wallpaper to the plastic membrane.

- **Acoustic ceilings made of perforated drywall boards with insulation, covered with acoustic fleece and open-pored, spray-on plaster**

This setup is extremely good for acoustics as it only has a slight impact on the mid-high range. Speakers must be flush mounted in EG Plan series back boxes and plastered.

The back boxes must be attached to the understructure as the perforated boards are not sufficiently mechanically stable. The acoustic fleece is then applied to the entire area and the plaster is sprayed over it.

- **Fleece wall covering (e.g. Capaver AkkordFleece Z130/150 K) that has been painted over**

This method does not present any problems mechanically and is excellent for acoustics. The fleece lining for the wall must be glued to the speaker membrane using the dispersion adhesive provided.

- **Rough and textured render**

Granular plasters are generally applied in layers thicker than 3 mm. Layering this amount of material over the speaker membrane has a significant impact on acoustic reproduction. It severely reduces efficiency levels and significantly dampens the mid-high range. In some cases, a digital signal processor (DSP) can be used to optimize the sound and achieve satisfactory acoustic reproduction. However, the maximum volume will still be significantly reduced. The membrane itself is flexible. As a result, the plaster over the membrane may crack or come away if it is subject to mechanical stress. You must check that the plaster has bonded with the fleece lining. In some cases, a plaster mesh can be used to prevent cracking.

Every plaster has different properties. We therefore strongly recommend preparing a sample area and seeing how this performs.

- **Clay plaster**

The information for rough and textured render also applies to clay plaster.

7. Influence of additional layers of paint when redecorating

Additional layers of emulsion paint have a minor impact on acoustic reproduction (see diagram). Additional layers of varnish will dampen sound in the mid-high range.

DE Plan 400

■ painted 2 x (standard) ■ painted 3 x ■ painted 4 x

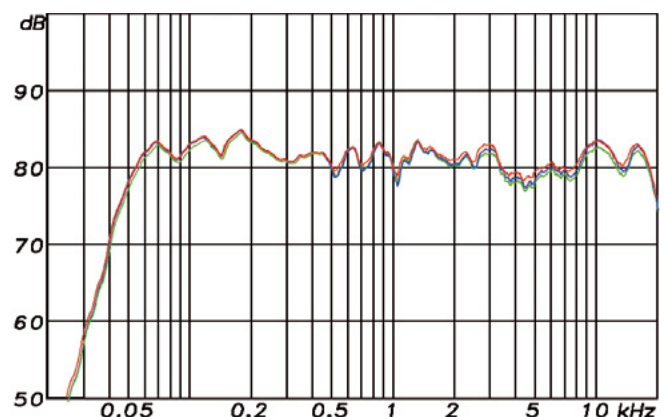

8. Installation in non-concrete walls and ceilings (without back box)

DE Plan speakers can be installed without back boxes in closed ceilings and walls. DE Plan 600 SUB subwoofers must always be installed with a back box, however, to ensure they can be correctly balanced.

We recommend using our EG/EGB back boxes if you are installing speakers in acoustic ceilings, solid walls or concrete ceilings and to minimize sound transmission to the rear. You can also insulate against sound transmission to the rear by adjusting the volume of the EG box you are using.

We recommend that you check the acoustic suitability of adjacent fixtures such as lighting.

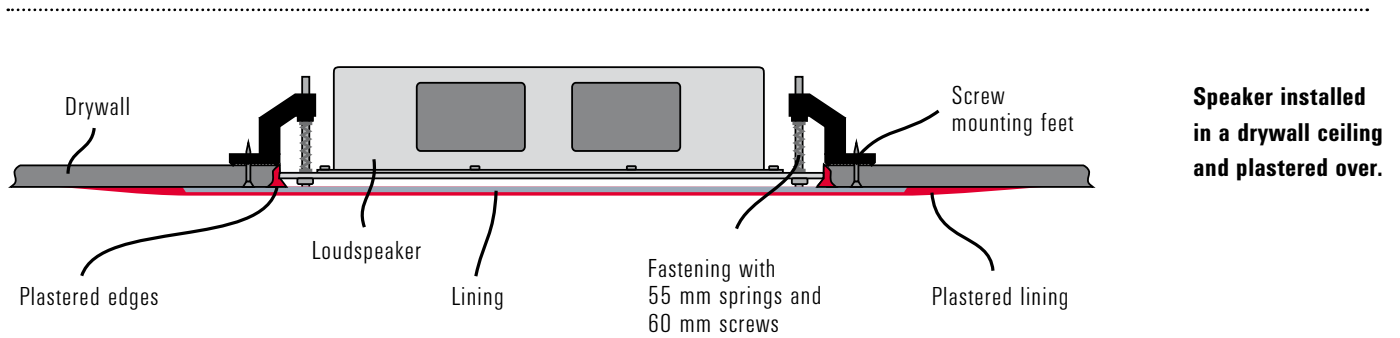

Installation steps



Locate and mark out the installation position.

Use the frame as a template (opening).



Cut out the opening.



Remove the insulating wool to reveal the opening for the speaker.



Trim the edges of the aperture at an angle.



Sand the edges.



Turn the feet of the box inwards.



Insert the mounting feet and assembly frame...



and screw in place.



Attach the terminal to the speaker cable.
Make sure the polarity is correct.



Apply a loose cable tie to the speaker.



Carefully remove the safety information label.



Connect the speaker.
Tighten the cable tie.



Insert the speaker...



and fix screws.



Adjust the speaker so it is flush mounted.
All screws must be under tension.



Clean the membrane...



and sand it.

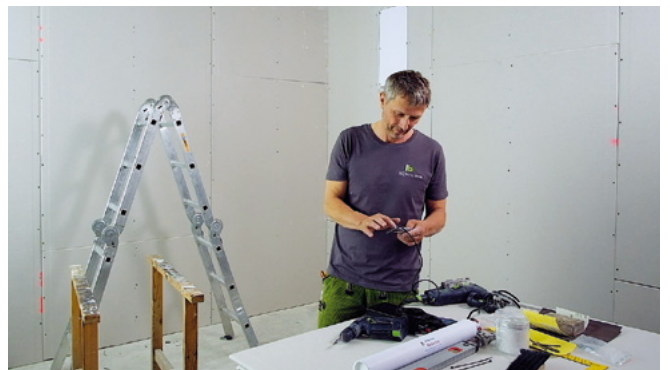

Test the speaker by playing music. **The speaker will not produce the correct sound until plastering is complete.**



Plaster twice over the edges and drill holes.
Leave to dry for at least 24 hours!



Sand the entire surface of the membrane using light pressure.



Evenly apply the adhesive.



Attach the lining while the adhesive is still moist. Press with your hand or a dry roller. **Leave to dry for at least 24 hours!**



Apply 1-2 thin layers of plaster over the entire surface.
Leave to dry for at least 24 hours!

*
Instructions
for applying
thicker layers
of filler



Sand the entire surface.
Only apply light pressure over the membrane.

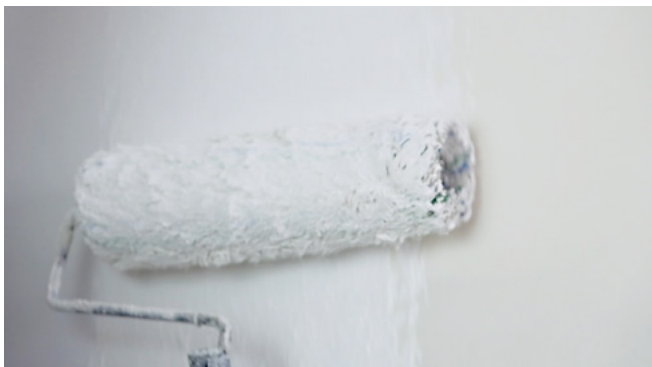

Paint.



Once painted, the speakers should be invisible.



Instructions for applying thicker layers of filler

If you want a layer that is thicker than 1 mm, apply the filler in multiple layers and make sure that each layer has dried out completely before you apply the next. If you do not do this, there is a risk that the moisture from the filler will soften the dispersion adhesive under the fleece causing the plastered area to come away from the wall.

9. Installation in drywall walls and ceilings with a back box

Use **EG Plan series back boxes** in walls or ceilings that are not closed (e.g. for acoustic ceilings, ventilated ceilings, open recessed lighting), or if you need additional sound proofing for adjacent rooms. The mounting feet for the speakers are already installed in these boxes. You will need to make the holes for cables in the back boxes. DE Plan 600 SUB subwoofers must always be installed with a back box to ensure they can be correctly balanced.

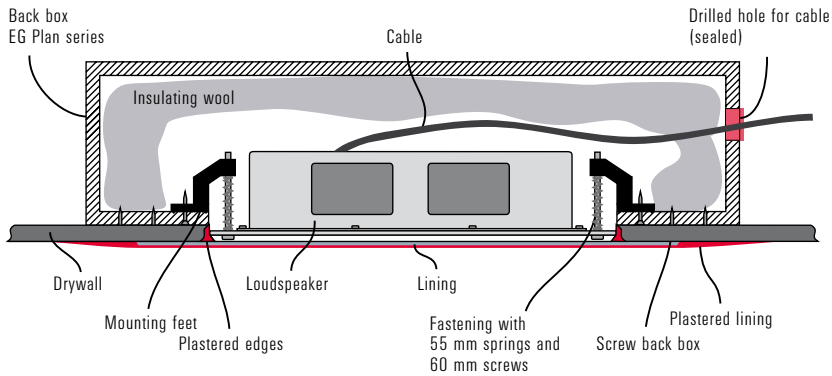

Speaker with back box installed in a drywall ceiling and plastered over.

EG Plan series back boxes (delivery with insulating wool)



EG Plan 200
400 × 350 × 100 mm



EG Plan 400
500 × 480 × 120 mm



EG Plan 500 S
620 × 240 × 100 mm



EG Plan 600
700 × 480 × 120 mm



Locate and mark out the installation position.
Use the frame as a template (opening).



Cut out the opening.



Trim the edges of the aperture at an angle.



Sand the edges.



Remove the loose insulating wool from the back box.



Drill a hole in the back box for the cable.



Screw the edge of the back box to the drywall sheet.



Insert the cable into the back box...



and screw the drywall sheet into the ceiling.
Seal the cable hole in the back box.



Attach the system terminal to the speaker cable.
Make sure the polarity is correct.

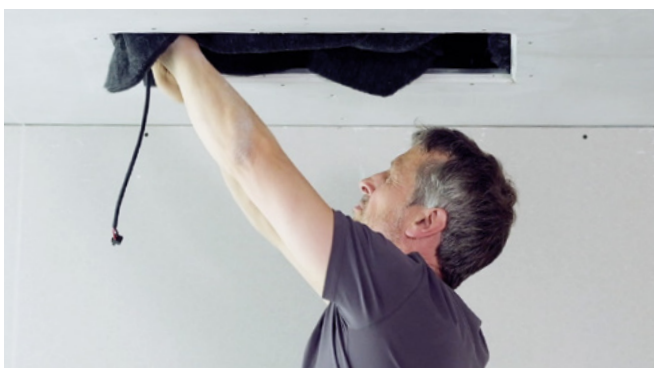

Line the box with the insulating wool...



and attach the springs.



Insert two assembly screws diagonally and secure with O-rings.



Apply a loose cable tie to the speaker.



Carefully remove the safety information label.



Connect the speaker cable and tighten the cable tie. Insert the speaker and attach it by fixing the first two screws.



Fix all the screws and adjust the speaker so it is flush mounted.
All screws must be under tension.



Clean the membrane...



and sand it.

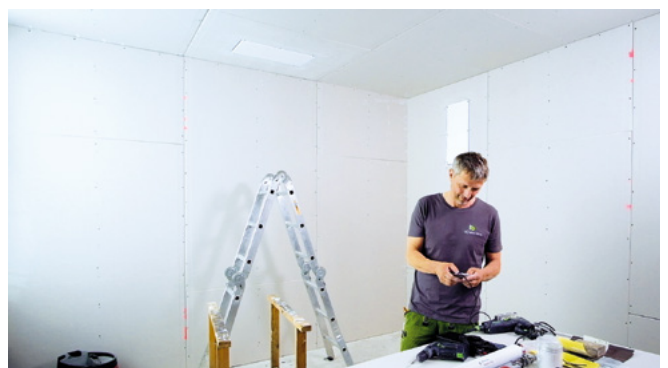

Test the speaker by playing music. **The speaker will not produce the correct sound until plastering is complete.**



Plaster twice over the edges and drill holes.
Leave to dry for at least 24 hours!



Sand the entire surface of the membrane using light pressure.



Evenly apply the adhesive...



and attach the lining.
Leave to dry for at least 24 hours!



*
Instructions
for applying
thicker layers
of filler.
See page 11

Apply 1-2 thin layers of plaster over the entire surface.
Leave to dry for at least 24 hours!



Sand the entire surface.
Only apply light pressure over the membrane.



Paint.



Once they have been painted, the speakers should be invisible.

10. Installation in solid walls using EGB Plan back boxes

When installing speakers in solid walls, please use our **EGB Plan series** plastic back boxes. The mounting feet for the speakers are already attached in these back boxes. You will have to make the holes for cables in the back box. Use the assembly adhesive/foam to fix the boxes in place.

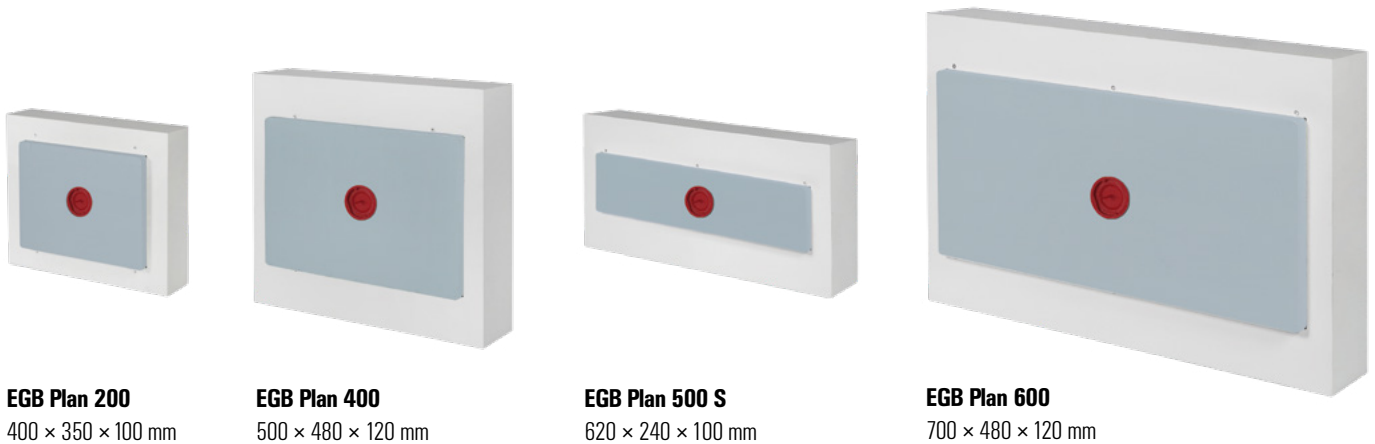

EGB Plan 200

400 × 350 × 100 mm

EGB Plan 400

500 × 480 × 120 mm

EGB Plan 500 S

620 × 240 × 100 mm

EGB Plan 600

700 × 480 × 120 mm

Installation steps

- Make the opening for the back box and cable and/or conduit in the brickwork.
- Use a conical drill bit to drill a hole in the side of the box for the cables and/or conduit and insert the cables.
- Install the EGB Plan series back box using settling mortar, or glue it in place using assembly foam. Make sure the box is **free from mechanical stress** (otherwise the position of the speaker may shift visibly over time).
- Place the plaster guard provided in the rigid foam insert to make it easier to find the position of the speaker once it has been plastered.
- Plaster the wall. Also plaster over the rigid foam insert in the speaker back box.
- Use a hammer to knock off the plaster covering the rigid foam insert and uncover the entire opening.
- Use a sharp utility cutter to cut through the rigid foam along the edges of the installation opening. You can now remove the rigid foam insert and the support structure.

Plastered solid wall with back box

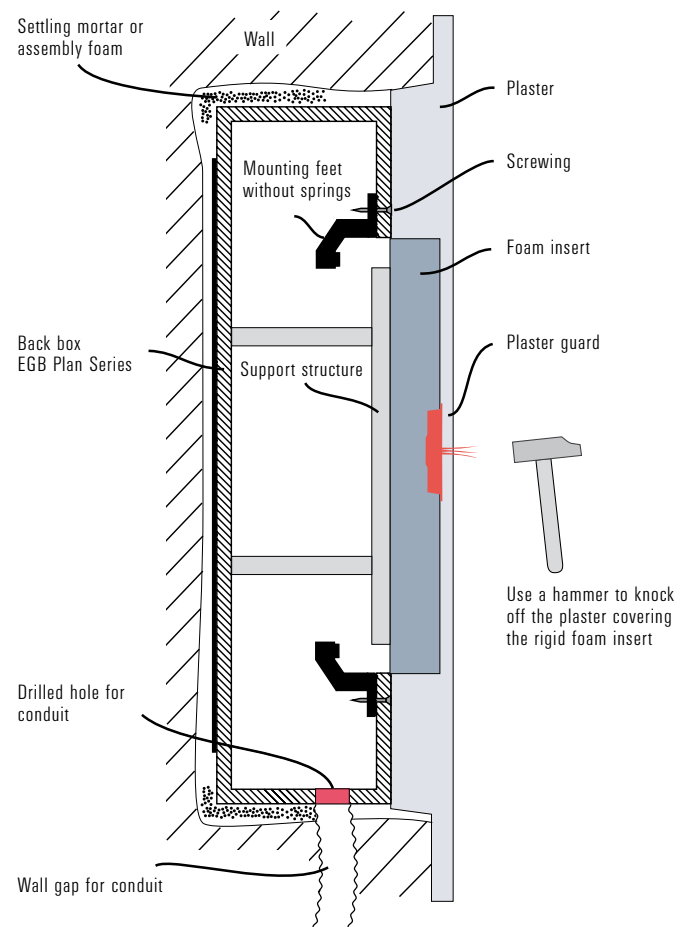

- Line the back box with the insulating wool provided.
- Place the 75 mm springs on the mounting feet.
- The rest of the installation is the same as the process for non-concrete ceilings described from page 12 onwards.

Use the 80 mm screws provided to mount the speaker.

! Special precautionary measures must be taken when applying rough render, textured render or similar plastering. Please refer to the information on pages 6 and 7 for further information.

Speaker installed and plastered

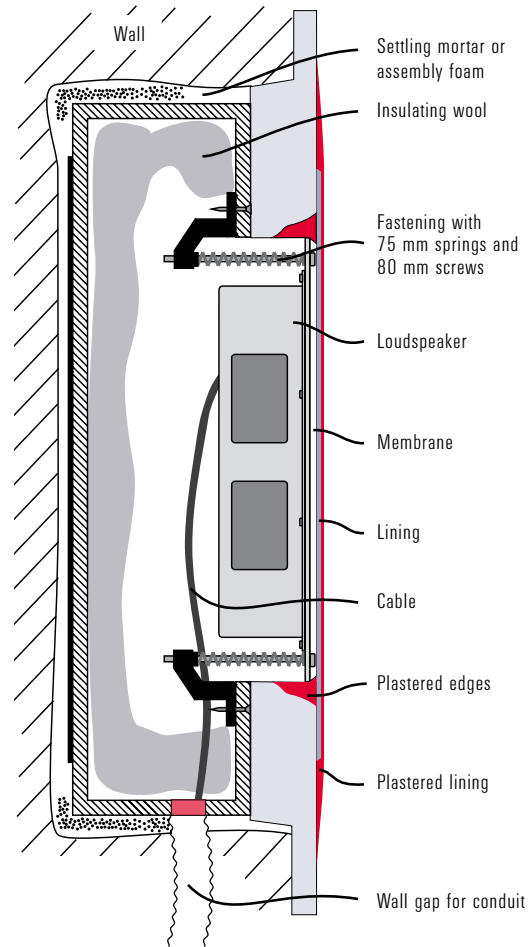

EGB series back box with assembly accessories

Scope of delivery:

- Back box
- Insulating wool
- Fabric tape (only for concrete cast in place)
- Nails for attaching the fabric tape to the formwork (only for concrete cast in place)
- Plaster guard

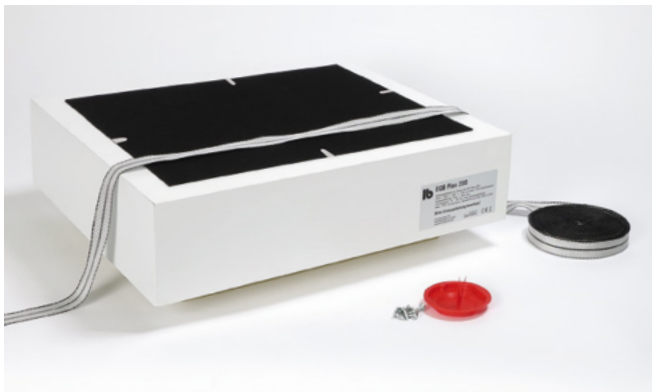

EGB Plan 200 with assembly components



EGB Plan 400 back boxes in a solid wall

11. Installation in concrete ceilings cast in place with EGB Plan series back boxes

When installing speakers in concrete ceilings cast in place, please use our **EGB Plan series** plastic back boxes.

The mounting feet for the speakers are already attached in these back boxes. You will have to make the holes for cables in the back boxes.

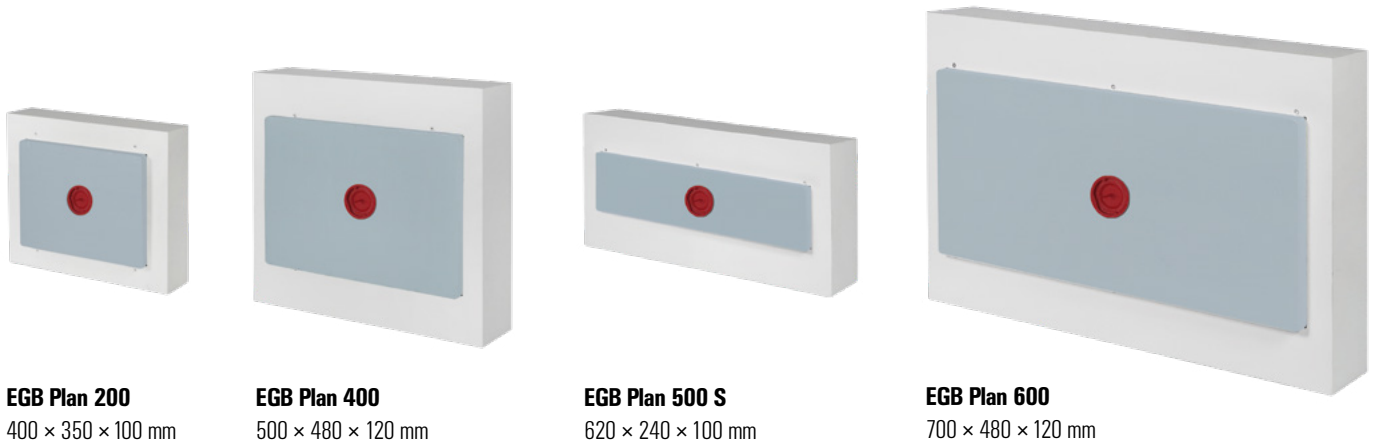

EGB series back box with assembly accessories

Scope of delivery:

- Back box
- Insulating wool
- Fabric tape (only for concrete cast in place)
- Nails for attaching the fabric tape to the formwork (only for concrete cast in place)
- Plaster guard



EGB Plan 200 with assembly components

Installation steps

- Use a conical drill bit to drill a hole for the cables or conduits in the side of the boxes and attach the cables.
- Place the boxes in the correct position on the formwork and attach the conduit.
- Use a laser level to adjust the position of the boxes.
- Attach the boxes to the formwork using fabric tape. Use the quick-fix screws provided to attach the tape to the edge of the box. Then place the tape on the formwork and nail it tightly in place. Cut the tape to the right length. The box can also be glued to the formwork to ensure it is precisely positioned.

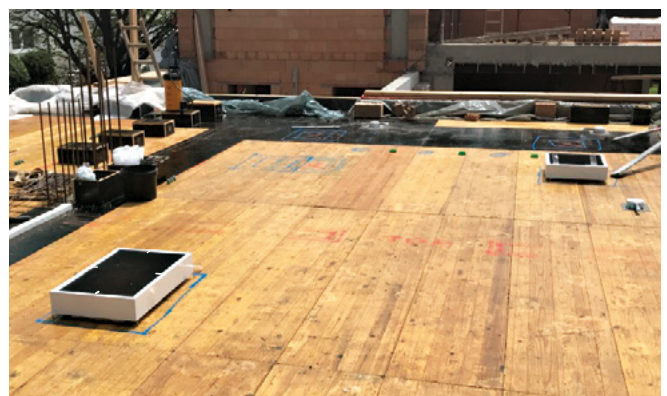

Positioning the back box on the formwork

- When poured, the concrete flows under the box until it reaches the rigid foam insert. The layer under the box is 28 mm thick.
- After the formwork has been removed, insert the plaster guard provided into the rigid foam insert so you can see the position of the speakers after plastering. When you plaster the ceiling, plaster over the rigid foam insert in the speaker back box.

Fixing back boxes on formwork

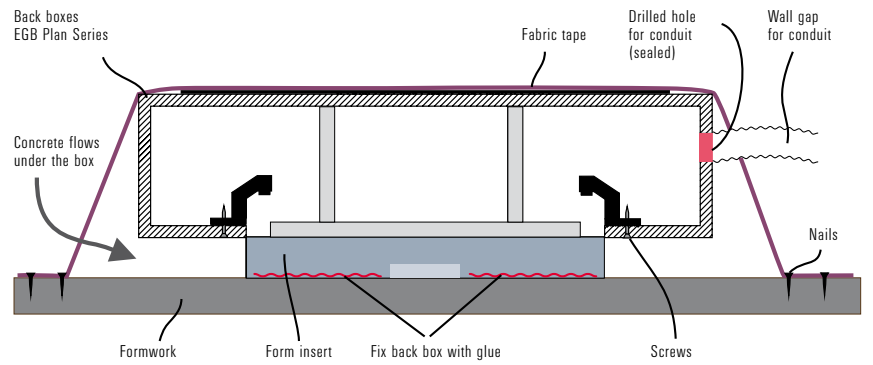

- Use a hammer to knock off the plaster covering the rigid foam insert and uncover all of the opening.
- Use a sharp utility cutter to cut through the rigid foam along the edges of the installation opening. You can now remove the rigid foam insert and the support structure.

Plastered in-situ concrete

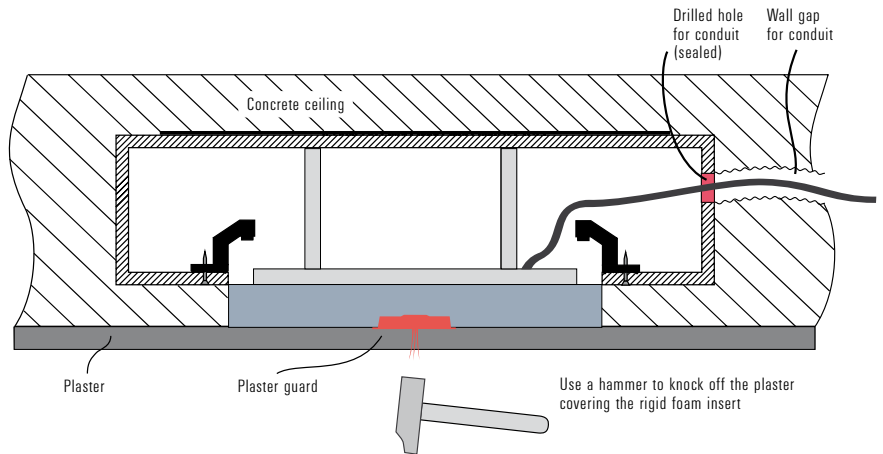

- Line the back box with the insulating wool provided.
- Place the 75 mm springs on the mounting feet.
- The rest of the installation is the same as the process for non-concrete ceilings described from page 12 onwards.

Use the 80 mm screws provided to mount the speakers.

Speaker installed and plastered

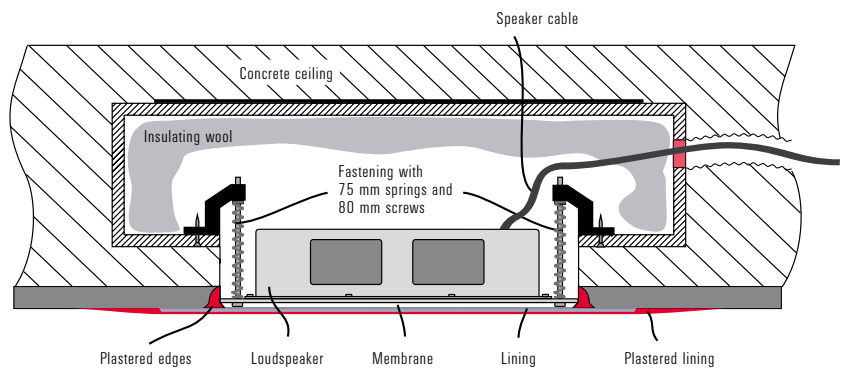

12. Installation in concrete ceilings with the EGB Plan series

When installing speakers in concrete ceilings, please use our **EGB Plan series** plastic back boxes. The mounting feet for the speakers are already installed in these boxes. You will have to make the holes for cables in the back boxes.

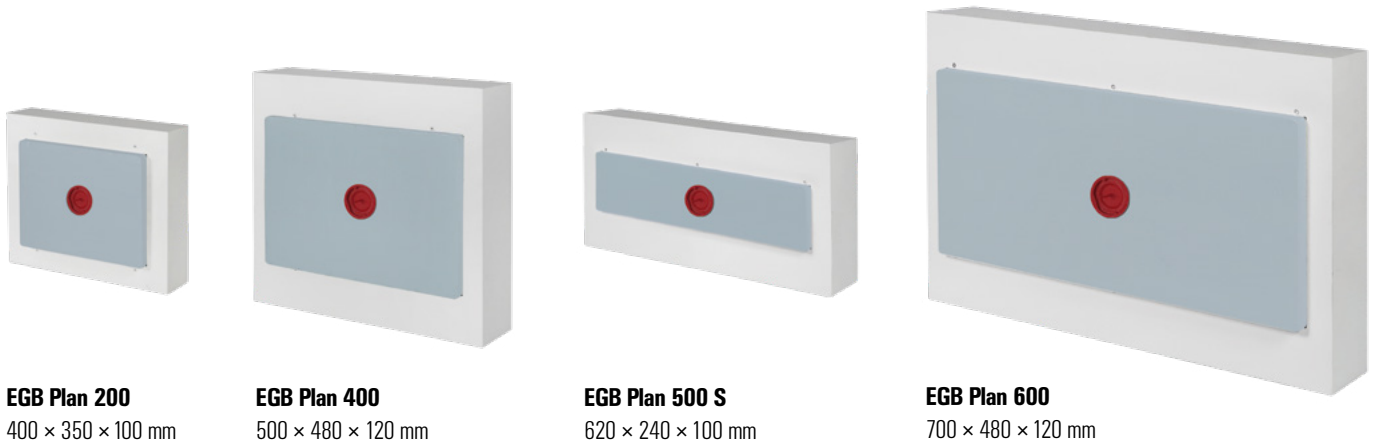

Back box with assembly accessories

Scope of delivery:

- Back box
- Fabric tape
- Quick-fix screws for attaching the fabric tape to the back boxes
- Self-adhesive plaster guard

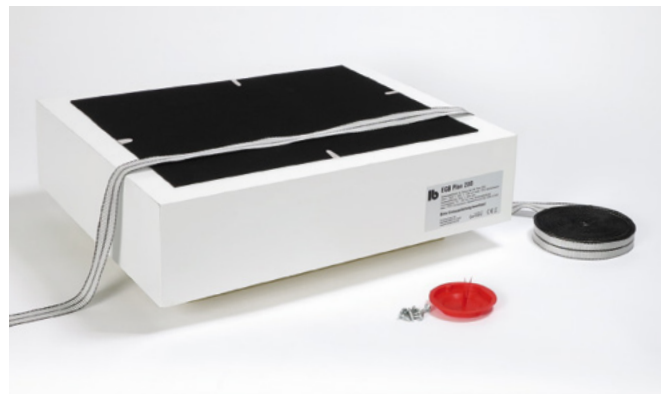

EGB Plan 200 with assembly components

If you are installing speakers in a concrete ceiling, the EGB series plastic back boxes must first be delivered to the concrete plant casting the ceiling. The boxes will be installed in the requisite ceiling modules at the plant.

The remaining installation steps are then carried out on the construction site.

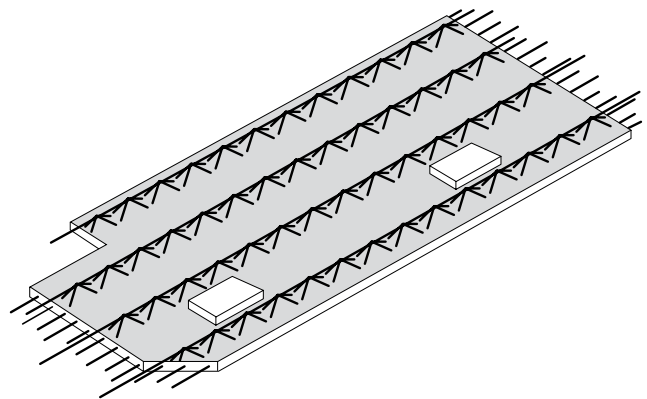

Prefabricated ceiling

Installation steps

- In the concrete plant, the back boxes must be positioned and attached to the formwork.
- When poured, the concrete flows under the box until it reaches the rigid foam insert. The layer under the box is 28 mm thick.

Finished prefabricated concrete ceiling

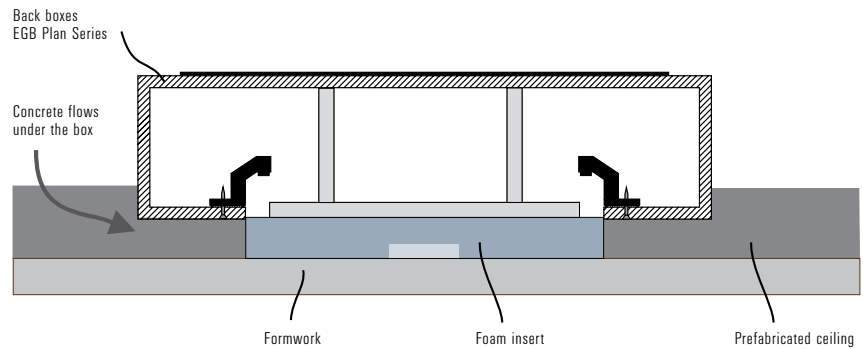

Once it has been poured, the concrete ceiling is finished off on site.

- Use a conical drill bit to cut holes in the side of the box for the conduits and lay the conduits.
- Pour the top concrete layer.
- After removing the formwork, use a sharp utility cutter to cut through the rigid foam along the edges of the installation opening. You can now remove the rigid foam insert and the support structure.

Finished concrete ceiling

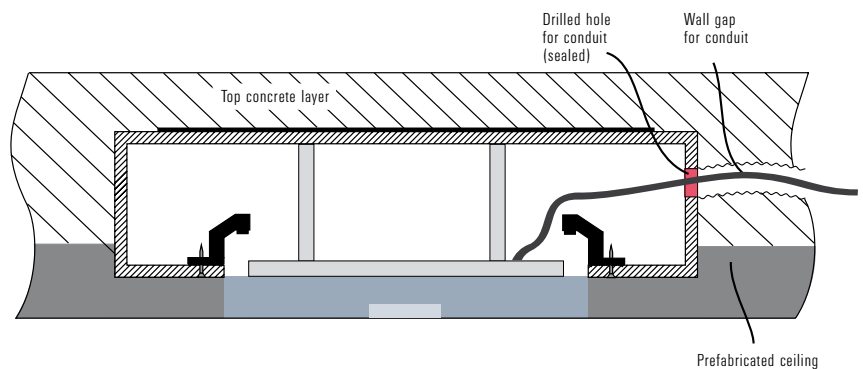



- Line the back box with the insulating wool provided.
- Place the 75 mm springs on the mounting feet.
- The rest of the installation is the same as the process for non-concrete ceilings described from page 12 onwards.

Use the 80 mm screws provided to mount the speakers.

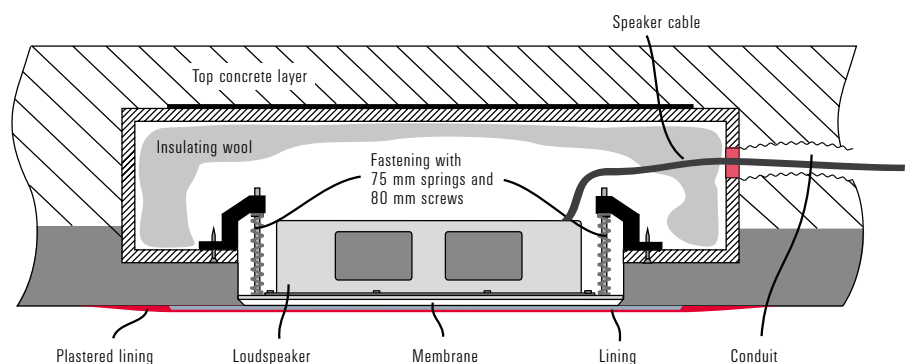



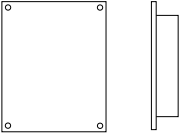
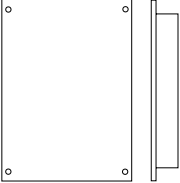
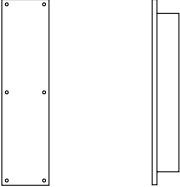
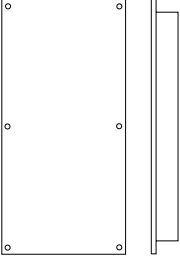

Speaker installed and plastered

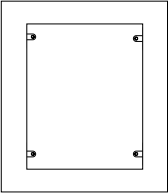
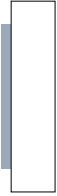
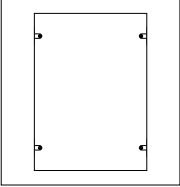

13. Technical data DE Plan Series

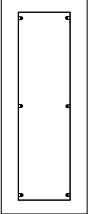
Models	Principle	Frequency range *	Power capacity 100 V Power taps	Sensitivity	Dispersion	Dimensions	Cutout size Installation depth	Weight	Connectors
	DE Plan 200	2-way flat transducer	70... 20.000 Hz	RMS/Prog. 40/80 Watts 8 Ohm	81 dB (1W/1m) max. 99 dB	180°	300 × 240 mm 300 × 310 mm Installation depth 72 mm	2,8 kg	2-pole
				7,5/15/30 Watt					
	DE Plan 400	2-way flat transducer	48... 20.000 Hz	RMS/Prog. 80/160 Watts 8 Ohm	82 dB (1W/1m) max. 104 dB	180°	420 × 300 mm incl. Mounting feet 420 × 370 mm	3,9 kg	2-pole
				15/30/60 Watts					
	DE Plan 500 S	2-way flat transducer	110... 20.000 Hz	RMS/Prog. 80/160 Watts 8 Ohm	82 dB (1W/1m) max. 104 dB	180°	540 × 140 mm incl. Mounting feet 560 × 210 mm	3,8 kg	2-pole
	DE Plan 600	2-way flat transducer	42... 20.000 Hz	RMS/Prog. 160/320 Watts 8 Ohm	83 dB (1W/1m) max. 108 dB	180°	620 × 300 mm incl. Mounting feet 626 × 370 mm	5,5 kg	8-pole
	DE Plan 600 AIArray	4-channel 2-way flat transducer	40... 20.000 Hz	RMS/Prog. 4 × 40/ 4 × 80 Watts 4 × 8 Ohm	86 dB (1W/1m) max. 110 dB	horiz. 180° vert. adjustable via DSC control software	620 × 300 mm incl. Mounting feet 626 × 370 mm	6,3 kg	8-pole
	DE Plan 600 SUB Only in conjunction with EG(B) Plan 600	Flat transducer	40... 180 Hz	RMS/Prog. 120/240 Watts 4 Ohm	82 dB (1W/1m) max. 105 dB	180°	620 × 300 mm incl. Mounting feet 626 × 370 mm	6,5 kg	2-pole

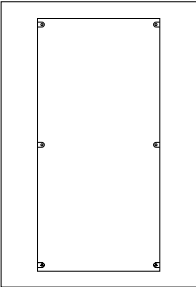
14. Technical data back boxes EG Plan / EGB Plan

Front	Side Form work EGB series	Models	Application	Loudspeaker type	Dimensions	Material	Weight	Accessories
		EG Plan 200	Drywall	DE Plan 200 (T) DE Plan 200 ST	400 × 350 × 100 mm	Plastic foam	2,2 kg	Insulating wool
		EGB Plan 200	Concrete and solid walls					
		EG Plan 400	Drywall	DE Plan 400 (T)	500 × 480 × 120 mm	Plastic foam	4,6 kg	Insulating wool
		EGB Plan 400	Concrete and solid walls					
		EG Plan 500 S	Drywall	DE Plan 500 S	620 × 240 × 100 mm	Plastic foam	2,3 kg	Insulating wool
		EGB Plan 500 S	Concrete and solid walls					
		EG Plan 600	Drywall	DE Plan 600 DE Plan 600 AIArray DE Plan SUB	700 × 480 × 120 mm	Plastic foam	6,8 kg	Insulating wool
		EGB Plan 600	Concrete and solid walls					

DE Plan installation videos
with or without back box on Youtube



**LB Lautsprecher
und Beschallungstechnik GmbH**

info@lb-lautsprecher.de
www.lb-lautsprecher.de
Steinerstr. 15 K · 81369 München
Tel +49 89 1893109-0 · Fax -29

Back: Private house Otterberg, Switzerland
Front: Private mansion, Mallorca

April 2022

Changes and errors excepted.

© LB Lautsprecher und Beschallungstechnik GmbH